



### Product Description

Carbery Plastics Chemical Dosing Tanks are designed and manufactured to ensure safe liquid storage for many Chemical applications.

Thanks to an unstressed one piece production process, rotationally moulded products and parts are characterized by excellent resistance properties.

Rotationally moulded products and parts will never rust, rot or corrode and do not require painting.

The vertical design of Carbery Plastics Chemical Tanks optimise space with large storage capacities over low footprint area.

With a team of certified plastic welding technicians and wide range of additional equipment available Carbery Plastics Chemical tanks can be customised to custom specifications.

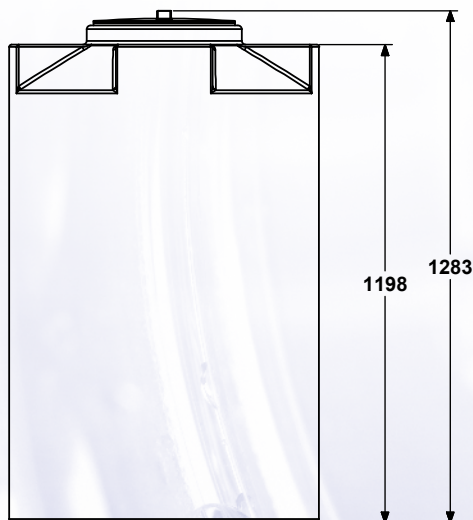
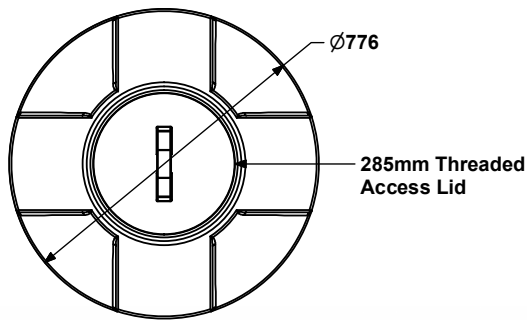
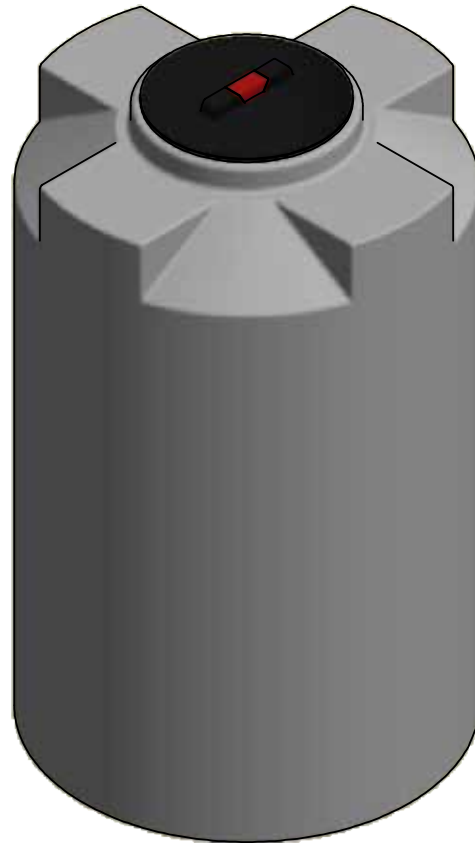

Technical Data	Value
Volume	400L
Dimensions D x H	776mm x 1283mm
Material	MDPE
Unladen Weight	21kg
Style	Vertical
Cover	285mm Threaded Lid
Inlet Fitting Options	1", 2"
Outlet Fitting Options	1", 2"
Tank Colour	Natural
Bund Colour	N/A

### Installation & Siting Guidelines

Carbery Tanks must only be installed and commissioned by a suitably competent person in accordance with supplied instructions and all prevailing statutory requirements.

Please Consult the Installation, Operation and Maintenance Manual for further Information.

Note: Dimensions are for guidance only, may vary marginally.